

**PROGRAMMING CONNECTOR**

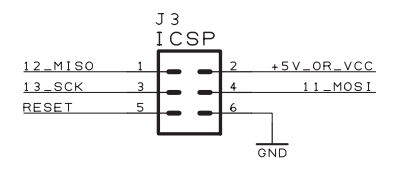

**OLED DISPLAY SSD1306 CONNECTOR**

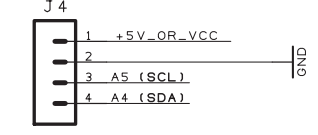

**RGB LED WS2812B**

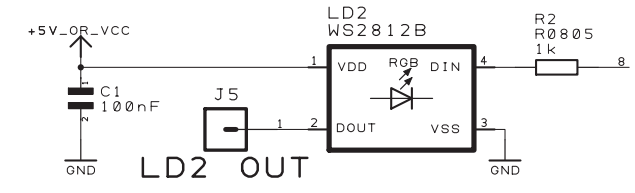

**POWER SUPPLY LED**

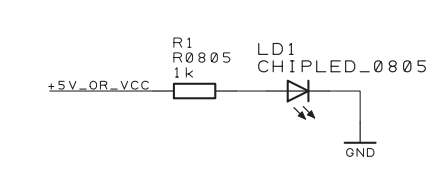

**PROGRAMMING SOCKET FOR ATtiny uC**

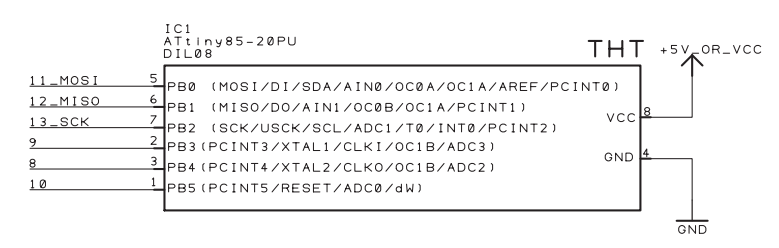

**BREAD BOARD SHIELD for ARDUINO**

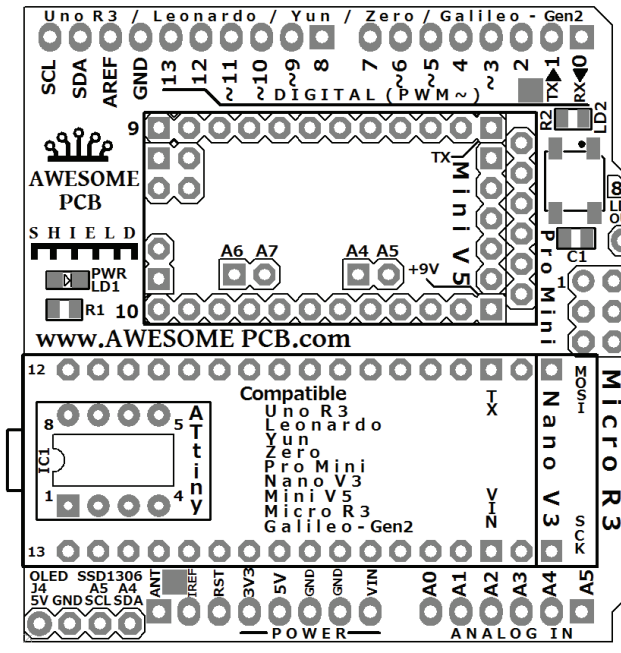
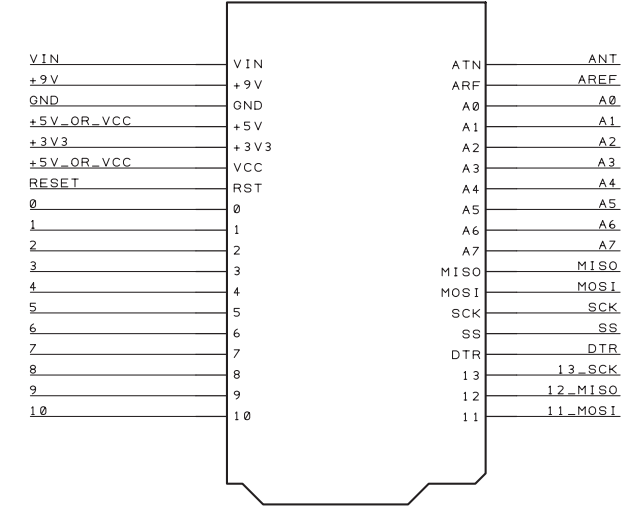

**BREAD BOARD POWER SUPPLY**

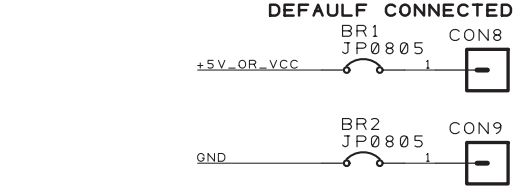

**Universal shield platform for Arduino boards**

www.AwesomePCB.com	
BREAD BOARD SHIELD	
Ardu SHIELD	
06-11-2016	REV06
16-10-2016	REV05
18-09-2016	REV04

www.AwesomePCB.com	
BREAD BOARD SHIELD	
Ardu SHIELD	
Sheet : 1/1	REV.06